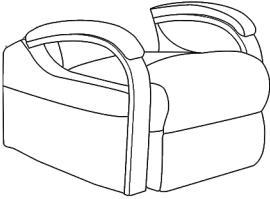
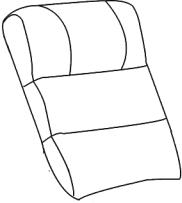
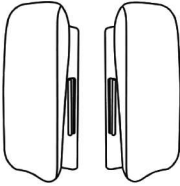

# ASSEMBLY INSTRUCTION FOR ACME FURNITURE

## MODEL#LV02879

Thank you for purchasing the quality product. Be sure to check all packing material carefully for small parts which may have come loose inside the carton during shipment. Separate, Identify and count all parts and metal hardware. Compare with all parts listed to be sure all parts are present. If any part(s) are missing or damaged, please contact your local furniture dealer. For efficient and speedy service, please indicate the model number and code letter of part(s) needed.

### COMPONENT PARTS

DESCRIPTION	PART NAME	Q'TY(PCS)
①:Chair Seat		1 PC
②:Chair Back		1 PC
③:Ears(Left&Right)		2 PC

### HARDWARE REQUIRED

A:Power Cord

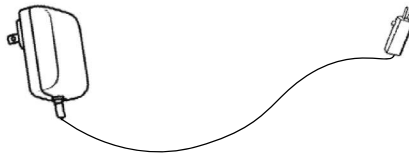

### Attention

\*\*\*Some number parts listed on the instruction sheet may not be in parts bag as they may be assembled. Carefully check parts and packing materials prior to ordering replacements. \*\*\*

# HOW TO ASSEMBLE:

## STEP 1

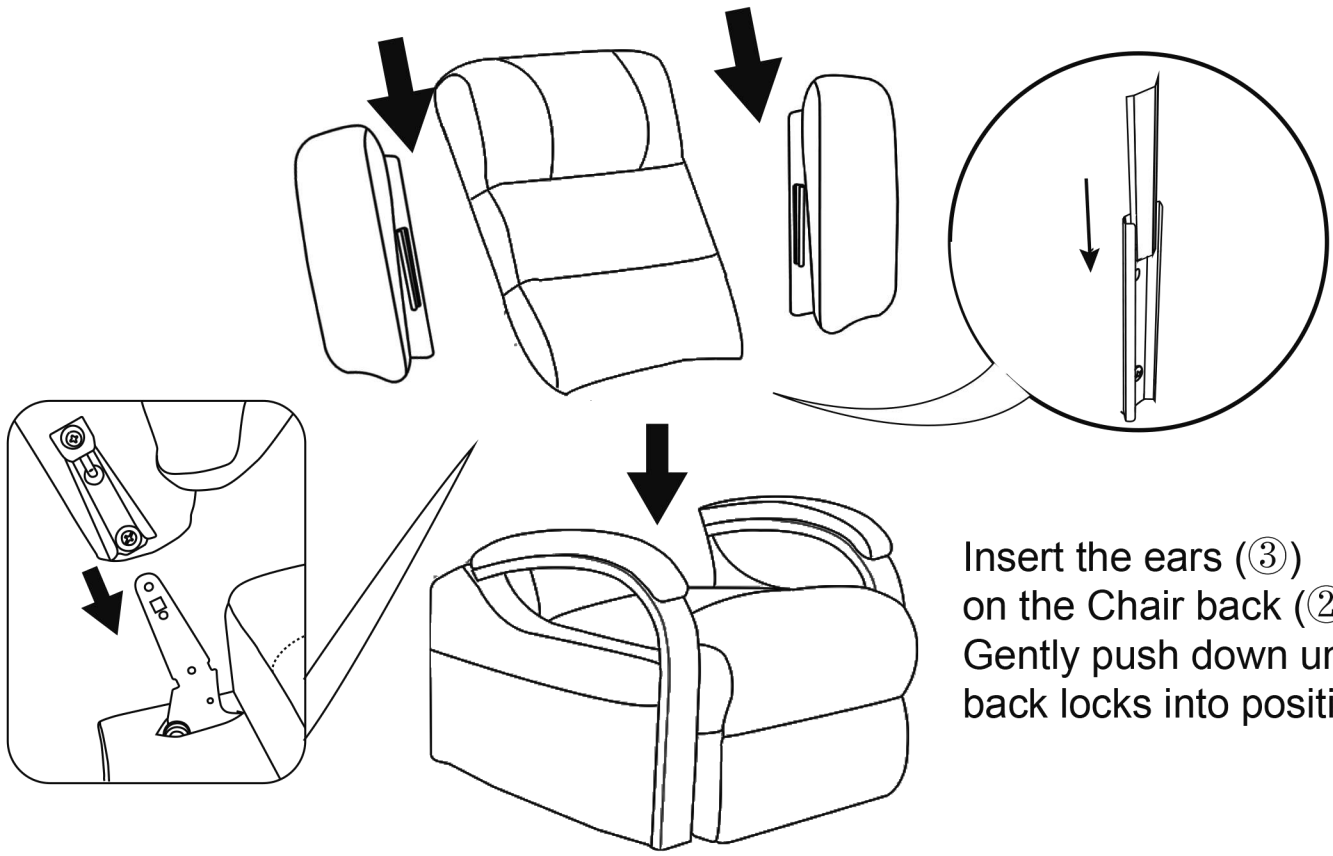

Insert the ears (③) on the Chair back (②), Gently push down until the back locks into position.

Insert the Chair back (②) on the Chair seat (①). Gently push down until the back locks into position.

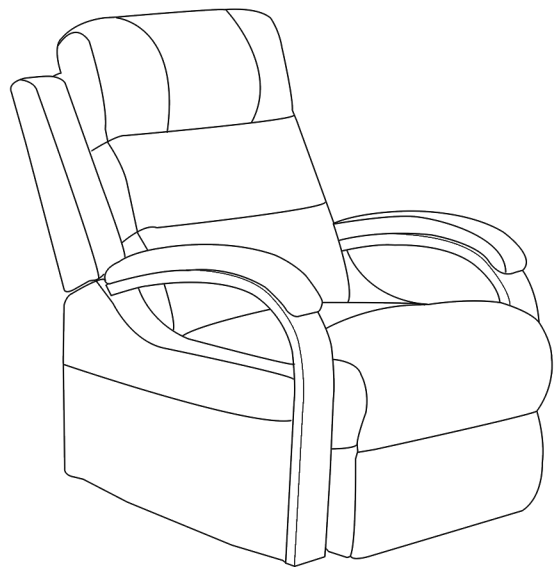

# HOW TO CONNECT THE MOTOR WIRES:

## STEP 2

No.I: Connect the white wire extending from the backrest to the white wire extending from the seat base.

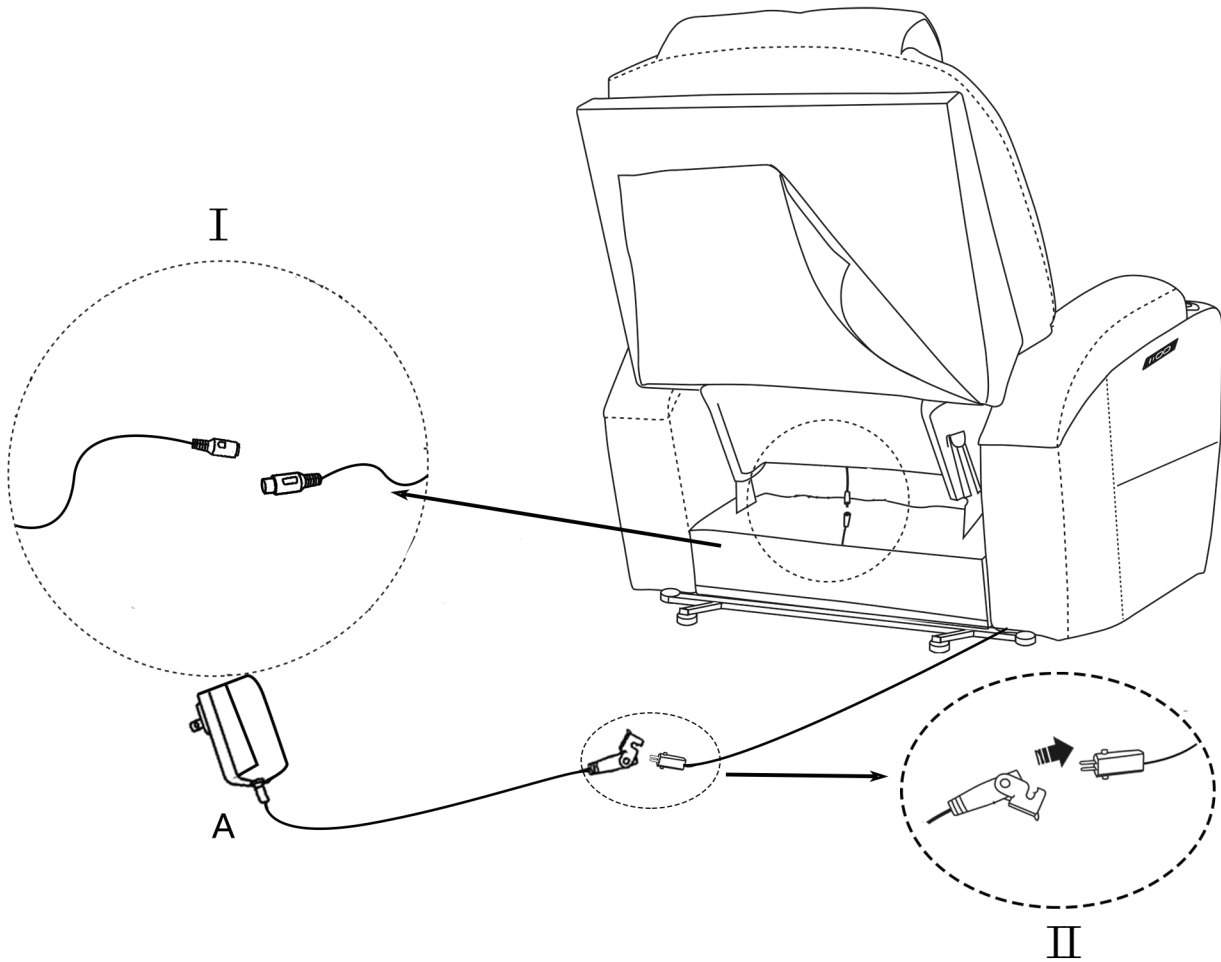

No.II: Wire connect the motor and Power cord (A).

# HOW TO USE MOTOR REMOTE:

## How to recline?



Press

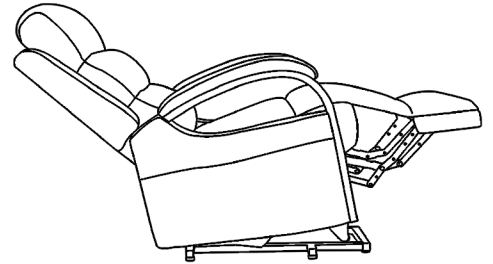
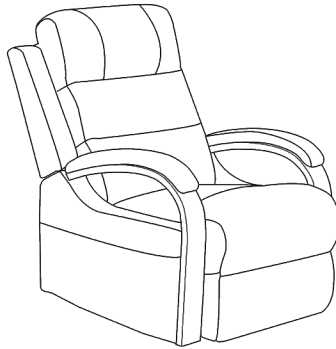

## How to get footrest latch down and stand?



Press

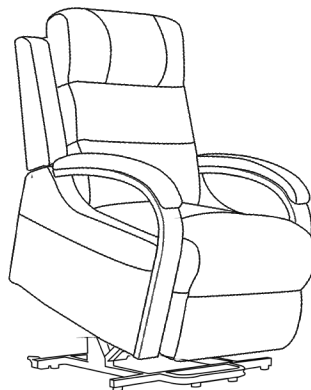
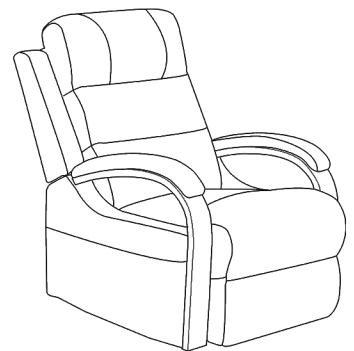
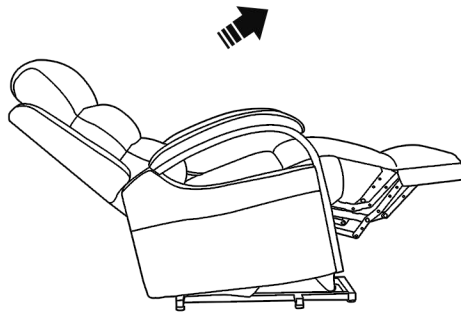

# HOW TO USE MASSAGE REMOTE:

